

Dust Collector with Fine Filter Cartridge

Operating Instructions



Producer:
Laguna Tools Inc
744 Refuge Way, Suite 200
Grand Prairie, Texas 75050
USA
Phone: +1 800-234-1976
Website: www.lagunatools.com

Distributor:
IGM nástroje a stroje s.r.o.
Ke Kopanině 560, 252 67, Tuchoměřice
Czech Republic, EU
Phone: +420 220 950 910
E-mail: sales@igmttools.com
Website: www.igmttools.com





EC DECLARATION OF CONFORMITY

According to the following EC Directives
- Machinery Directive : 2006/42/EC



The undersigned, Stephen Stoppenbrink, representing Laguna Tools Inc.
744 Refuge Way, Suite 200, Grand Prairie, Texas 75050 USA, manufacturer, declares that
the machine described hereafter :

DUST COLLECTOR

MODEL:

AFLUX12 (230V/50Hz)
BFLUX1 (230V/50Hz)
CFLUX3 (415V/50Hz)
PFLUX3 (415V/50Hz)
CFLUX1 (230V/50HZ)
PFLUX1 (230V/50HZ)

Provided that it is used and maintained in accordance with the generally accepted codes of good practice and the recommendations of the instructions manual, meets the essential safety and health requirements of the Machinery Directive.

The person who compile technical file established within the EU:

Name: IGM nastroje a stroje s.r.o.

Address: Ke Kopanine 560, Tuchomerice , CZ-252 67

Tel.: +420 220 950 910

Email: sales@igmtools.com

The TCF (No. SF-2018001-A1 / SF-2018002-A1) is archived in CEPROM S.A. located in Str. Fântânele, nr.FN (Platforma Industrială), 440240 Satu Mare, Romania

For the most specific risks of this machine, safety and compliance with the essential requirements of the Directive has been based on elements of:

- EN ISO 12100:2010 / Safety of machinery — General principles for design — Risk assessment and risk reduction (ISO 12100:2010)
- EN 60204-1: 2006+A1:2009+AC:2010 / Safety of machinery - Electrical equipment of machines- Part 1: General requirements- Industrial electrical device.

Date: August 04, 2022

Authorized Signature: 

Position: Chief Executive Officer

Place: Laguna Tools Inc.
744 Refuge Way, Suite 200, Grand Prairie, Texas 75050,
USA

EN - English

Operating Instructions (Laguna original)

Dear Woodworker,

Thank you for your purchase and welcome to the Laguna Tools group of discerning woodworkers. We understand that you have a choice of where to purchase your machines and appreciate the confidence you have in the Laguna Tools brand. Every machine manufactured by Laguna Tools has been carefully designed and well thought through from a woodworker's perspective. Through hands-on experience, Laguna Tools is constantly working hard to make innovative, precision products. Products that inspire you to create works of art, are a joy to run and work on, and encourage your performance.

Contents

1. Declaration of conformity

1.1 Warranty

2. BFlux Specifications

3. General Safety

3.1 Important Safety Instructions

3.2 General Safety Rules

3.3 Additional Safety For Dust Collectors

3.4 Power Connections

3.5 Motor Specifications

3.6 Grounding Instructions

3.7 Extension cords

4. BFlux Assembly

4.1 Assembly

5. Maintenance

6. Troubleshooting

1. Declaration of conformity

We declare that this product is in compliance with the directive and the standard mentioned on the previous page of this manual.

1.1 Warranty

IGM Tools & Machinery strives to always deliver high-quality machinery. The warranty is governed by the valid terms and conditions of IGM Tools & Machinery available at www.igmtools.com.

2. BFlux Specifications

Motor	750 W (1HP)
Power supply	230V / 50Hz / 1 fáze
Recommended breaker	16A, tripping characteristic C
Airflow (traditional method measuring)	884m ³ /hour
Airflow (realistic method measuring)	748m ³ /hour
Fan Diameter	230 mm
Inlet Diameter	100 mm
Switch	Motor mounted direct switch
Noise Level	76 dB(A) at 3 m
Packing Size (WxDxH)	830 x 510 x 630 mm
Net weight	32 kg
Shipping weight	35 kg
Filter	Filtered area: 1.6 m ²
Cartridge filter	360 mm diameter x 300 mm height
Filtrance	1 micron 99.7 %
Filter Collection Bag Layflat Size	600 x 900 mm

3. General Safety

3.1 Important Safety Instructions

Read and understand all warnings and operating instructions before using this equipment. Failure to follow all instructions listed below, may result in electric shock, fire, and/or serious personal injury or property damage.

Woodworking can be dangerous if safe and proper operating procedures are not followed. As with all machinery, there are certain hazards involved with the operation of the product. Using the machine with respect and caution will considerably lessen the possibility of personal injury. However,

if normal safety precautions are overlooked or ignored, personal injury to the operator may result. Safety equipment such as guards, push sticks, hold-downs, featherboards, goggles, dust masks and hearing protection can reduce your potential for injury. But even the best guard won't make up for poor judgment, carelessness or inattention. Always use common sense and exercise caution in the workshop. If a procedure feels dangerous, don't try it. Figure out an alternative procedure that feels safer. Remember: Your personal safety is your responsibility.

This machine was designed for certain applications only. We strongly recommend that this machine not be modified and/or used for any application other than that for which it was designed. If you have any questions relative to a particular application, DO NOT use the machine until you have first contacted the manufacturer to determine if it can or should be performed on the product.

If you have any questions relative to its application DO NOT use the product until you have contacted the manufacturer and we have advised you.

When using an electrical appliance, basic precautions should always be followed, including the following:

READ ALL INSTRUCTIONS BEFORE USING THIS MACHINE

To reduce the risk of fire, electric shock, or injury:

- Do not leave appliance when plugged in. Unplug from outlet when not in use and before servicing.
- Do not use outdoors or on wet surfaces.
- Do not allow to be used as a toy. Close attention is necessary when used by or near children.
- Use only as described in this manual. Use only manufacturer's recommended attachments.
- Do not use with damaged cord or plug. If appliance is not working as it should, has been dropped, damaged, left outdoors, or dropped into water, return it to a service centre.
- Do not pull or carry by cord, use cord as a handle, close a door on cord, or pull cord around sharp edges or corners. Do not run appliance over cord. Keep cord away from heated surfaces.
- Do not unplug by pulling on cord. To unplug, grasp the plug, not the cord.
- Do not handle plug or appliance with wet hands.
- Do not put any object into openings. Do not use with any opening blocked; keep free of dust, lint, hair, and anything that may reduce air flow.
- Keep hair, loose clothing, fingers, and all parts of body away from openings and moving parts.
- Turn off all controls before unplugging.
- Use extra care when cleaning on stairs.
- Do not use to pick up flammable or combustible liquids, such as gasoline, or use in areas where they may be present.
- Connect to a properly grounded outlet only. See Grounding Instructions.

SAVE THESE INSTRUCTIONS

- Read and understand the warnings posted on the machine and in this manual. Failure to comply with all of these warnings may cause serious injury.

- Replace the warning labels if they become obscured or removed.
- This Portable Cyclone Dust Collector is designed and intended for use by properly trained and experienced personnel only. If you are not familiar with the proper and safe operation of this type of dust collector, do not use until proper training and knowledge have been obtained.
- Do not use this machine for other than its intended use. If used for other purposes, IGM nástroje a stroje s.r.o. and Laguna Tools Inc. disclaims any real or implied warranty and holds itself harmless from any injury that may result from that use.
- Always wear approved safety glasses/face shields while using this machine.
- Before operating this dust collector, remove tie, rings, watches and other jewelry, and roll sleeves up past the elbows. Remove all loose clothing and confine long hair. Non-slip footwear or anti-skid floor strips are recommended. Do not wear gloves.
- Wear ear protectors (plugs or muffs) during extended periods of operation.
- Some dust created by power sanding, sawing, grinding, drilling and other construction activities contain chemicals known to cause cancer, birth defects or other reproductive harm. Some examples of these chemicals are:
 - Lead from lead based paint.
 - Crystalline silica from bricks, cement and masonry products.
 - Arsenic and chromium from chemically treated lumber.

Your risk of exposure varies, depending on how often you do this type of work. To reduce your exposure to these chemicals, work in a well-ventilated area and work with approved safety equipment, such as face or dust masks that are specifically designed to filter out microscopic particles.

- Do not operate this machine while tired or under the influence of drugs, alcohol or any medication.
- Make certain the switch is in the OFF position before connecting the machine to the power source.
- Make certain the machine is properly grounded.
- Make all machine adjustments or maintenance with the machine unplugged from the power source.
- Form a habit of checking to see that all extra equipment such as adjusting keys, wrenches, scrap, stock, and cleaning rags are removed away from the machine before turning on.
- Keep safety guards in place at all times when the machine is in use. If removed for maintenance purposes, use extreme caution and replace the guards immediately when maintenance is complete.
- Make sure the dust collector is on a flat even surface and the wheels locked in place before use.
- Check damaged parts. Before further use of the machine, a guard or other part that is damaged should be carefully checked to determine that it will operate properly and perform its intended function. Check for alignment of moving parts, binding of moving parts, breakage of parts, mounting and any other conditions that may affect its operation. A guard or other part that is damaged should be properly repaired or replaced.
- Provide for adequate space surrounding work area and non-glare, overhead lighting.
- Keep the floor around the machine clean and free of scrap material, oil and grease.
- Keep visitors a safe distance from the work area. Keep children away.
- Make your workshop child proof with padlocks, master switches or by removing starter keys.
- Give your work undivided attention. Looking around, carrying on a conversation and “horse-play” are careless acts that can result in serious injury.
- Maintain a balanced stance at all times so that you do not fall or lean against the dust collector. Do not overreach or use excessive force to perform any machine operation.

- Use the right tool at the correct speed and feed rate. Do not force a tool or attachment to do a job for which it was not designed. The right tool will do the job better and safer.
- Use recommended accessories; improper accessories may be hazardous.
- Maintain machinery with care. Follow instructions for lubricating and changing accessories.
- Turn off the machine before cleaning. Use a brush or compressed air to remove dust or debris — do not use your hands.
- Do not stand on the machine. Serious injury could occur if the machine tips over.
- Never leave the machine running unattended. Turn the power off and do not leave the machine until it comes to a complete stop.

3.2 General safety rules

WARNING: FAILURE TO FOLLOW THESE RULES MAY RESULT IN SERIOUS PERSONAL INJURY.

CHECK DAMAGED PARTS. Before further use of the unit, properly repair or replace any part that is damaged.

FOR YOUR OWN SAFETY, READ AND UNDERSTAND THE INSTRUCTION MANUAL BEFORE OPERATING THE MACHINE.

Learn the unit's application and limitations as well as the specific hazards peculiar to it.

KEEP WORK AREA CLEAN. Cluttered areas and benches invite accidents.

DON'T USE IN DANGEROUS ENVIRONMENT. Don't use this unit in damp or wet locations, or expose it to rain. Keep work area well-lighted.

KEEP CHILDREN AND VISITORS AWAY. All children and visitors should be kept a safe distance from work area.

DISCONNECT UNIT before servicing.

CHECK DAMAGED PARTS. Before further use of the unit, properly repair or replace any part that is damaged.

FAILURE TO FOLLOW THESE RULES MAY RESULT IN SERIOUS INJURY.

3.3 Additional Safety Instructions

Additional safety for dust collectors

Intended use. This dust collector is only intended for collecting wood dust and chips from woodworking machines. Do not use this dust collector to collect metal, dirt, pebbles, drywall, asbestos, lead paint, silica, liquids, aerosols, or any flammable, combustible, or hazardous materials.

Hazardous dust. Dust created while using machinery may cause cancer, birth defects, or long-term respiratory damage. Be aware of dust hazards associated with each work piece material, and always wear a NIOSH-approved respirator to reduce your risk.

Dust allergies. Dust from certain woods may cause an allergic reaction in people and animals. Make sure you know what type of wood dust you will be exposed to in case there is a possibility of an allergic reaction.

Wear respirator. Fine dust that is too small to be caught in the filter will be blown into the ambient air during operation. Always wear a NIOSH-approved respirator during operation and for a short time after to reduce your risk of permanent respiratory damage.

Emptying dust. When emptying dust from the collection container, wear a respirator and safety glasses. Empty dust away from ignition sources and into an approved container.

Disconnecting power supply. Turn the switch off, disconnect the dust collector from the power supply, and allow the impeller to come to a complete stop before leaving the machine unattended or doing any service, cleaning, maintenance, or adjustments.

Suspended dust particles and ignition sources. Do not operate the dust collector in areas where explosion risks are high. Areas of high risk include, but are not limited to, areas near pilot lights, open flames, or other ignition sources.

Fire suppression. Only operate the dust collector in locations that contain a fire suppression system or have a fire extinguisher nearby.

Impeller hazards. Do not place your hands or tools near the open inlet during operation for any reason. The powerful suction could easily cause accidental contact with the impeller, which will cause serious personal injury or damage to the machine. Always keep small animals and children away from open dust collection inlets.

Avoiding sparks. Do not allow steel or rocks to strike the impeller—this may produce sparks. Sparks can smolder in wood dust for a long time before a fire is detected. If you accidentally cut into wood containing tramp metal (nails, staples, spikes, etc.), immediately turn off the dust collector, disconnect it from power, and wait for the impeller to stop—then empty the collection container into an approved airtight metal container.

Operating location. To reduce respiratory exposure to fine dust, locate permanently installed dust collectors away from the working area, or in another room that is equipped with a smoke detector. Do not operate the dust collector in rainy or wet locations—exposure to water may create a shock hazard or decrease the life of the machine.

Static electricity. Plastic dust lines generate high amounts of static electricity as dust chips pass through them. Although rare, sparks caused by static electricity can cause explosions or fire. To reduce this risk, make sure all dust lines are thoroughly grounded by using a grounding wire.

Regular cleaning. Regularly check/empty the collection bags or drum to avoid the buildup of fine dust that can increase the risk of fire. Make sure to regularly clean the surrounding area where the machine is operated—excessive dust buildup on overhead lights, heaters, electrical panels, or other heat sources will increase the risk of fire.

Warning: If precautions are not heeded, it may result in minor injury and/or possible machine damage.

Warning: If precautions are not heeded, it may result in serious injury or possibly even death.

SAVE THESE INSTRUCTIONS.

Refer to them often and use them to instruct others.

3.4 Power Connections

A separate electrical circuit should be used for your machines. This circuit should not be less than #12 wire and should be protected with a 16 Amp time lag fuse, tripping characteristic C. If an extension cord is used, use only 3-wire extension cords which have 3-prong grounding type plugs and matching receptacle which will accept the machine's plug. Before connecting the machine to the power line, make sure the switch (s) is in the "OFF" position and be sure that the electric current is of the same characteristics as indicated on the machine. All line connections should make good contact. Running on low voltage will damage the machine.

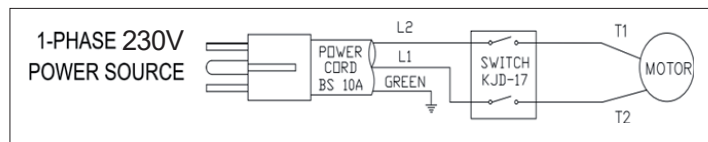

3.5 Motor Specifications

Your machine is wired for 230V, 50 HZ alternating current. Before connecting the machine to the power source, make sure the switch is in the "OFF" position.

3.6 Grounding Instructions

This machine must be grounded while in use to protect the operator from electric shock.

Cord Connection:

In the event of a malfunction or breakdown, grounding provides a path of least resistance for electric current to reduce the risk of electric shock. This machine is equipped with an electric cord having an equipment-

grounding conductor and a grounding plug. The plug must be plugged into a matching outlet that is properly installed and grounded in accordance with all local codes and ordinances. Do not modify the plug provided - if it will not fit the outlet, have the proper outlet installed by a qualified electrician. Improper connection of the equipment-grounding conductor can result in risk of electric shock. The conductor with insulation having an outer surface that is green with or without yellow stripes is the equipment-grounding conductor. If repair or replacement of the electric cord or plug is necessary, do not connect the equipment-grounding conductor to a live terminal. Check with a qualified electrician or service personnel if the grounding instructions are not completely understood, or if in doubt as to whether the machine is properly grounded. Use only 3-wire extension cords that have 2-prong grounding type plugs and matching 2-conductor receptacles.



EuroPlug - CEE 7/7

3.7 Extension Cords

Use proper extension cords. Use proper extension cords. Make sure your extension cord is in good condition and has a matching receptacle which will accept the machine's plug. When using an extension cord, be sure to use one heavy enough to carry the current of the machine.

4. Setup

4.1 Assembly

Tools required

Wrenches 10 and 12 mm (supplied in hardware pack)



SEVERE LACERATION HAZARD. TURN THE UNIT "OFF", DISCONNECT THE UNIT from the power source and wait 2- 1/2 minutes to allow time for internal rotating components to stop before installing or removing accessories, before adjusting or changing set-ups, clearing clogs or when making repairs. For your own safety, do not connect the machine to the power source until the machine is completely assembled. Please also make sure that you read and understand the entire instruction manual.

ASSEMBLY TIME ESTIMATE 1 to 2 hours

CASTERS

1. Locate the bag of hardware with the flat washers and hex bolts for the four plate mount casters. Each caster requires four of each washer and bolt.



2. Make sure you have the base in the position with the four bolt holes for each plate mount caster facing upwards to assemble each caster.



3. Place each caster with the plate mount on the base. Take the hex bolt and washer and insert through the plate mount and thread into the base. Tighten each bolt. Do the same for the other three casters.



SIDE SUPPORTS

1. Place the base with the casters on the bottom. Make sure you place the side with the two bolt holes on each leg of the base to your right side when looking down on it.

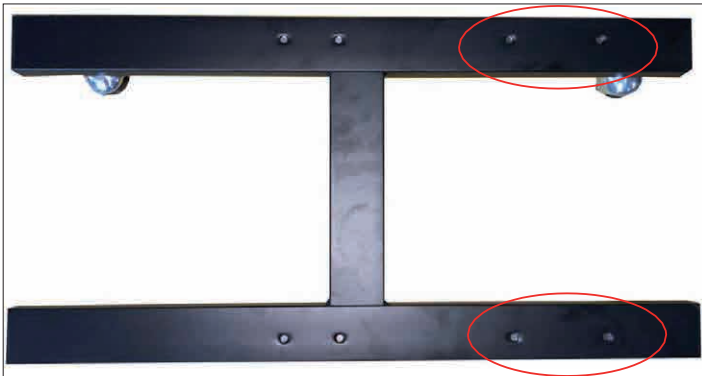

2. Locate the side supports labelled on the inside with "L" and "R".



Front side



Back side

3. The base below shows where each side support needs to go.

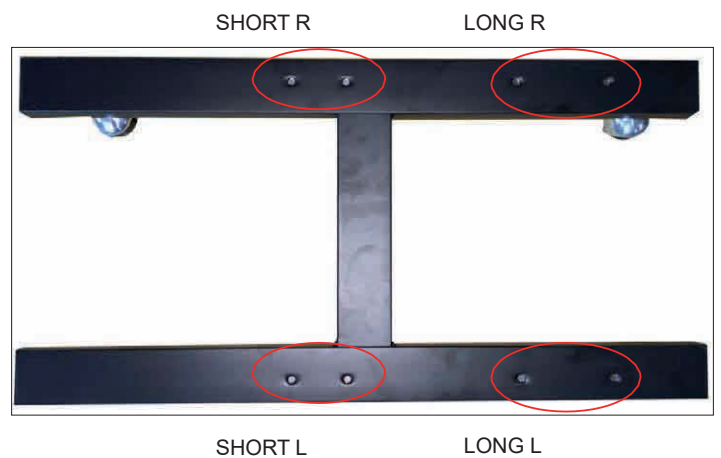

4. Place the Long side support labeled "L" in an upright position with the slant facing inwards towards the middle of the base. The angle of the picture below has been taken on the opposite side to show the label "L".



5. Align the two holes in the bottom end of the long side support with the two holes in the base. Use screws (8 mm x 19 mm) and flast washers to align (8 mm). Tighten the bolt securely.

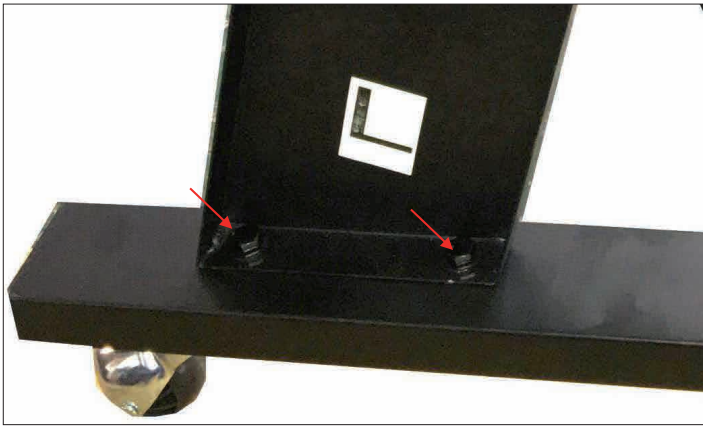

6. Place the short side support labelled "L" in an upright position with the slant facing long side support.



7. Align the two holes on the top end of the short side support to with the two bolt holes on the middle of the long side support. Screw together using hex bolts (8 mm x 19 mm) and washers (8 mm). Tighten securely.

8. Align the two holes on the bottom end of the short side support to the two bolt holes in the base. Screw together using hex bolts (8 mm x 19 mm) and washers (8 mm). Tighten securely.



9. Repeat this process for the remaining side supports labelled "R".

10. The figure below shows both side supports assembled.



11. Locate the support brace and place inside the two side supports.
Note: Make sure the support is attached to the side supports closest to the motor.



12. Align the four holes in the support brace with the four holes in the side supports as shown below.

13. Screw together using hex bolts (8 mm x 19 mm) and washers (8 mm). Tighten securely.



ATTACHING THE MOTOR AND DUST CHUTE TO THE FRAME

1. Place the motor and dust chute on their side.
2. Align the four holes, two shown at C, on the top of the side supports (A), with the four holes on the dust chute (B).
3. Screw together using hex bolts (8 mm x 19 mm) and washers (8 mm).
4. Repeat this process for the three remaining holes.
5. Carefully lift the assembly up with the wheels on the bottom and dust chute on top.

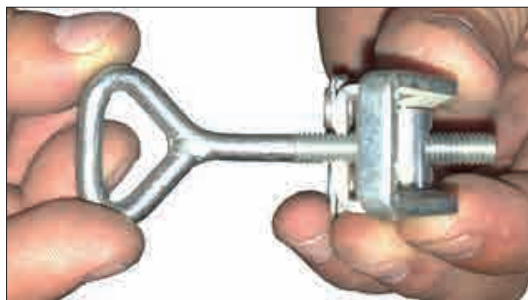

INTAKE ADAPTER TO THE DUST CHUTE

1. Line up four holes in the intake adapter (one shown as X) with four holes in the dust chute.
2. Screw together using 1,3 cm screws.

SEVERE LACERATION HAZARD. - TURN THE UNIT OFF, disconnect from power source and wait for the motor to stop. Now you can maintain, repair or adjust the machine. The collector is **not** supplied with a hose. Please assemble your own 100 mm hose to the intake adapter and secure it with a hose clamp. Assemble the other end of the flexible hose and to the woodworking machine and secure with a hose clamp. **IMPORTANT:** Do not operate the dust collector without the flexible hose assembled.



CANISTER FILTER TO CHUTE

1. Take the canister filter and fit the open end to the top channel on the dust chute.
2. Locate the adjustable band clamp from the hardware and take the end with the clamp and key bolt. Adjust the length of the band clamp by tightening or loosening the key bolt.
3. Secure adjustable band clamp around the bottom end of the canister filter.
4. Hook the key bolt onto the other end of the clamp and push the handle (one shown as A) down to secure tightly.

COLLECTION BAGS TO CHUTE

DISCONNECT THE MACHINE FROM THE POWER SOURCE!

USING THE CLOTH SNAP BAND RING:

1. Place the cloth-covered snap band ring inside the opening of the clear plastic collection bag. Fold about 15 cm of the bag around the snap band ring.
2. Place the bag in the large opening in the dust chute. Fit the snap band ring into the bottom channel. Bend and fold the snap band ring to fit into place.
3. Tug slight on the bag to eliminate any slack and make sure that the bag is secure and will not detach during collection.

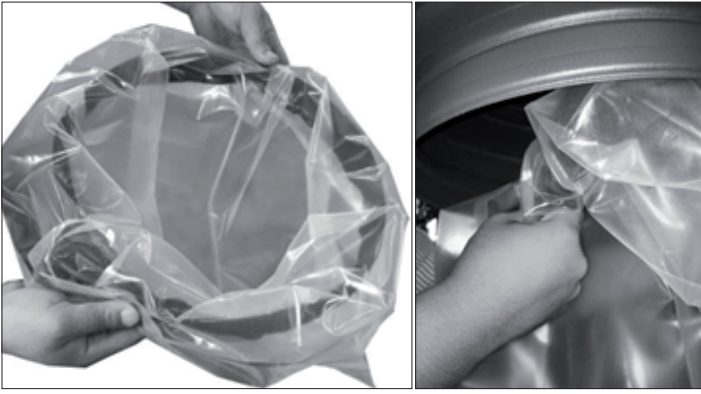

USING A METAL BAG CLAMP

You can also attach the plastic bag to the outside of the dust collector using the included metal bag clamp.

1. Place the metal bag clamp around the top of the plastic bag. Fold about 10 cm of plastic bag over the clamp.
2. Place the metal bag clamp and plastic bag on the dust chute. Fasten the metal bag clamp securely.



5. Maintenance

CLEANING THE FILTER

To ensure proper operation of this Dust Cyclone, the canister filter must have adequate air flow. This means the filter must be regularly maintained by carefully blowing the filter clean using compressed air and an air gun to release built-up particulates trapped between the filter pleats.

For heavy duty users, it is recommended to use compressed air on a regular basis to maintain maximum filtration efficiency and longer life span of the filter.

Using the Filter Cleaner Crank

The filter cleaner crank knocks dust particulate and small debris from the pleated filter and into the filter bag.

To keep your machine in good working condition, it is recommended that you use the filter cleaner crank to clean the filter after every use.

To clean the filter using the crank simply rotate the crank handle clockwise four or five rotations.

Using Compressed Air

Disconnect machine from power!

For heavy duty users, it is recommended to use compressed air on a weekly basis to maintain maximum filtration efficiency and longer life span of the filter.

ROUTINE INSPECTION

It is a good idea to routinely inspect any quality woodworking tool in order to keep it in optimum condition. This includes inspecting all hardware for tightness, ensuring the filter is clean, and cleaning debris and grime from any surfaces and moving parts.

6. Troubleshooting

Machine does not start or a breaker trips.

Possible Cause	Possible Solution
<ol style="list-style-type: none"> 1. Power supply switched OFF or is faulty. 2. Wall fuse/circuit breaker is blown/tripped. 3. Incorrectly wired motor connection. 4. On-board circuit breaker is tripped. 5. Wiring is open/has high resistance. 6. Faulty power switch. Motor is at fault. 	<ol style="list-style-type: none"> 1. Ensure power supply is ON and has the correct voltage. 2. Ensure adequate circuit size; install inlet restrictor, replace weak breaker. 3. Rewire or call certified service technician or electrician. 4. Allow motor to cool, improve ventilation, press reset button. 5. Check for broken wires or poor connections, repair as necessary. 6. Replace switch. Test/repair/replace.

Excessive vibration or noise during operation.

Possible Cause	Possible Solution
<ol style="list-style-type: none"> 1. Loose component. 2. Loose or broken motor mount. 3. Motor fan hitting fan cover. 4. Bad motor bearings. 	<ol style="list-style-type: none"> 1. Inspect and tighten all bolts/nuts. 2. Tighten or replace as needed. 3. Check fan and cover; replace as needed. 4. Rotate shaft manually, check for grinding or loose shaft, replace bearings if needed.

Loud, repetitive noise, or excessive vibration coming from cyclone.

Possible Cause	Possible Solution
<ol style="list-style-type: none"> 1. Machine is on uneven surface. 2. Damaged/Unbalanced impeller. 3. Loose connections. 4. Impeller is loose. 5. Motor fan hitting fan cover.sahuje kryt. 	<ol style="list-style-type: none"> 1. Stabilize on a flat surface. 2. Inspect impeller for dents, bends, loose fins. Replace if needed. 3. Check and re-tighten all fasteners. 4. Replace the motor and impeller. 5. Check fan and cover; replace as needed.

Dust collector does not adequately collect dust or chips; poor performance.

Possible Cause	Possible Solution
<ol style="list-style-type: none"> 1. Canister end bag is full. Filter is dirty. 2. Restricted duct line. 3. Suction route is too long or has too many sharp bends. 4. Wet lumber is clogging ducts. 5. Leaks in the duct work or too many open ports. 6. Inadequate velocity in the main suction line. 7. Wrong size ducting/ports used. 	<ol style="list-style-type: none"> 1. Empty canister end bag. Clean filter. 2. Clean inlet adapter. 3. Move machine closer to the point of suction, and rerun ducts to eliminate sharp bends. 4. Use lumber with less than 20% moisture content. 5. Repair all duct leaks and close any ports not being used. 6. Increase velocity by opening 1 or 2 more blast gates to different branch lines. 7. Re-size and re-install ducts and fittings.

Sawdust being blown into the air from the dust collector.

Possible Cause	Possible Solution
<ol style="list-style-type: none"> 1. Band clamp or end bag is not secure. 2. Loose or damaged seals. 	<ol style="list-style-type: none"> 1. Re-install ensuring a tight fit. 2. Replace seals and gaskets.

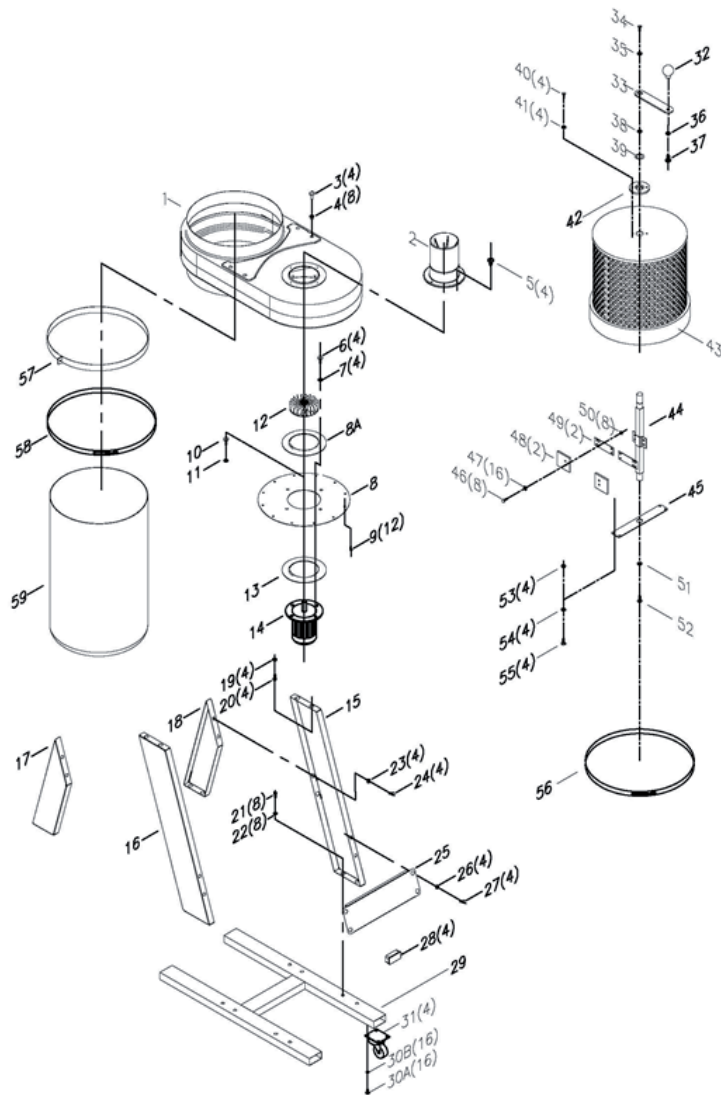

Index	Item Description	Specification	Qty
1	DUST CHUTE		1
2	INTAKE SPLITTER	4"	1
3	HEX BOLT	5/16"*3/4"	4
4	NUT	5/16"	8
5	SHEET METAL THREAD BOLT	#8x1/2"	4
6	HEX BOLT	5/16"*3/4"	4
7	FLAT WASHER	5/16"*OD18*2t	4
8	MOTOR BASE SUPPORT		1
8A	GASKET		1
9	HEX SPRING BOLT	5/16"*5/8"	12
10	HEX BOLT	5/16"*3/4"	1
11	FLAT WASHER	5/16"*OD30*3t	1
12	FAN	9"	1
13	MOTOR RUBBER GASKET		1
14	MOTOR	1HP/230V/50HZ/1PHASE	1
15	SIDE SUPPORT – LONG	Right	1
16	SIDE SUPPORT – LONG	Left	1
17	SIDE SUPPORT – SHORT	Left	1
18	SIDE SUPPORT – SHORT	Right	1
19	FLAT WASHER	5/16"*OD18*2t	4
20	HEX BOLT	5/16"*3/4"	4
21	HEX BOLT	5/16"*3/4"	8
22	FLAT WASHER	5/16"*OD18*2t	8
23	FLAT WASHER	5/16"*OD18*2t	4
24	HEX BOLT	5/16"*3/4"	4
25	SUPPORT BRACE		1
26	FLAT WASHER	5/16"*OD18*2t	4
27	HEX BOLT	5/16"*3/4"	4
28	PLUG	30*60mm	4
29	BASE		4

30A	HEX BOLT	1/4"	4
30B	FLAT WASHER	1/4"	
31	2"WHEEL		4
32	HANDLE	22mmL	1
33	ROTATION ARM		1
34	HEX BOLT	5/16"*3/4"	1
35	FLAT WASHER	5/16"*OD30*3t	1
36	FLAT WASHER	3/8"*OD23*2t	1
37	LOCK NUT	3/8"	1
38	C-SHAPED CLAMP	Ø20	1
39	SEAL	OuterØ30*Inner Ø20*5t	1
40	HEX BOLT	1/4"*3/4"	4
41	FLAT WASHER	1/4"*OD19*2t	4
42	BEARING	Ø70* Ø20.5*7t	1
43	CANISTER FILTER	Ø350*300mm	1
44	ROTATION SHAFT		1
45	SUPPPORT PLATE		1
46	HEX BOLT	1/4"*5/8"	8
47	FLAT WASHER	1/4"*OD13*1t	16
48	CANVAS		2
49	PEDAL		2
50	LOCK NUT	1/4"	8
51	FLAT WASHER	5/16"*OD23*2t	1
52	HEX BOLT	5/16"*3/4"	1
53	LOCK NUT	1/4"	4
54	FLAT WASHER	1/4"*OD13*1t	4
55	HEX BOLT	1/4"*3/4"	4
56	ADJUSTABLE BAND CLAMP	Ø350mm	1
57	BLACK SNAP BAND	Ø350mm	1
58	SPRING BAG CLAMP	Ø350mm	1
59	PLASTIC BAG	Ø350mm*980mm	2



IGM nástroje a stroje s.r.o., Ke Kopanině 560,
Tuchoměřice, 252 67, Czech Republic, EU
+420 220 950 910, www.igmtools.com